

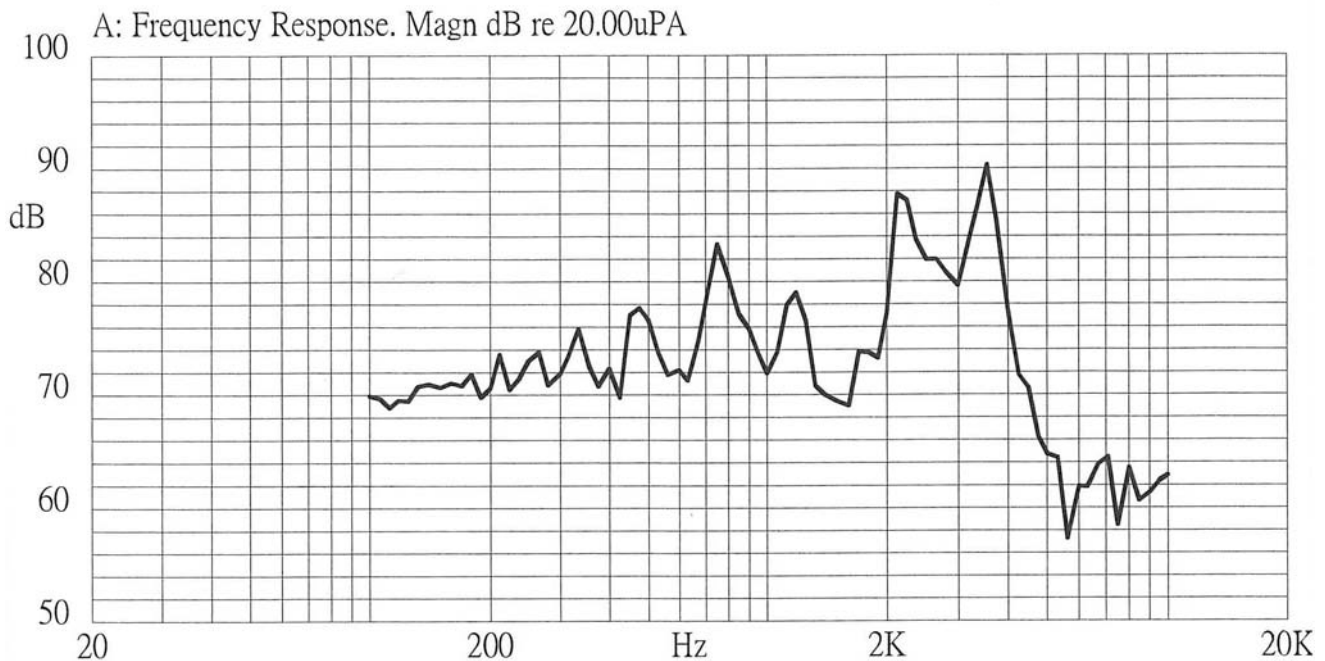
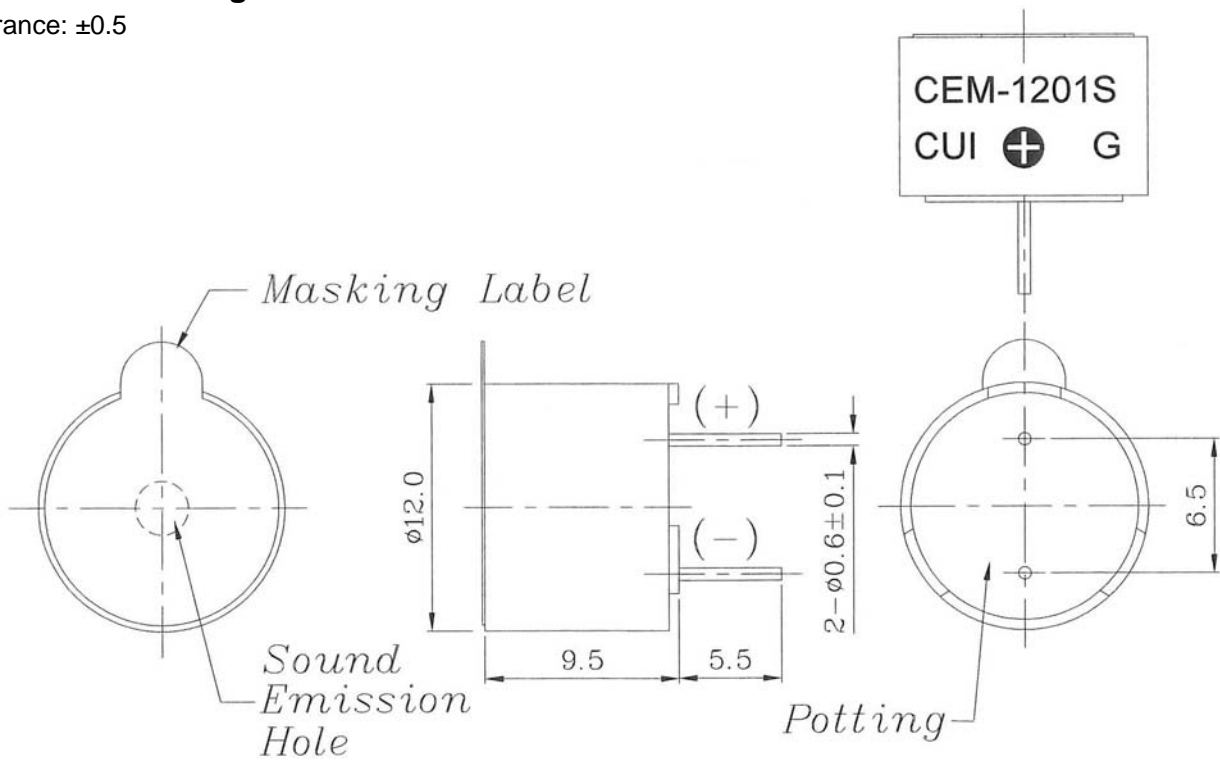
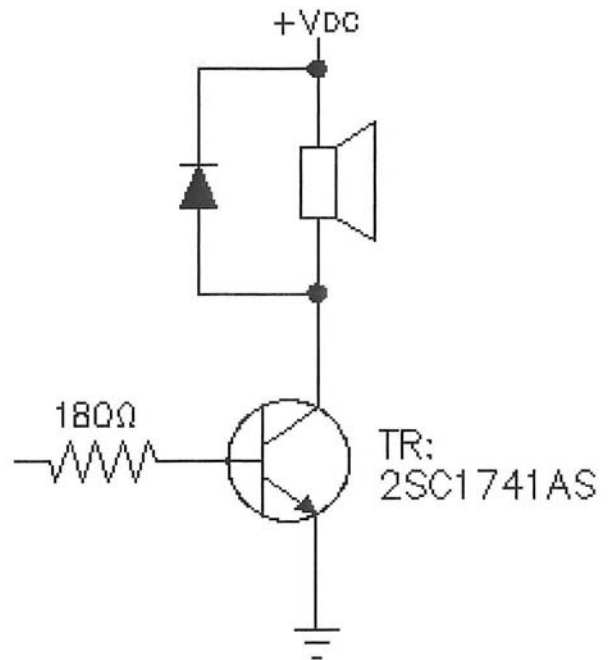
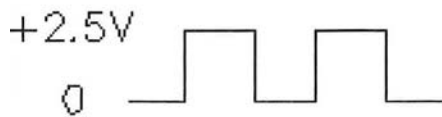

Specifications

Rated voltage	1.5 Vo-p	
Operating voltage	1.0 - 3.0 Vo-p	
Mean current	40 mA max.	
Coil resistance	16 ±3 Ω	Applying rated voltage, 2400 Hz square wave, ½ duty
Sound output	Min. 80 (Typical 88) dBA	Distance at 10cm (A-weight free air). Applying rated voltage of 2400 Hz, square wave, 1/2 duty.
Rated frequency	2,400 Hz	
Operating temperature	-20 ~ +60° C	
Storage temperature	-30 ~ +70° C	
Dimensions	ø12.0 x H9.5 mm	See attached drawing
Weight	1.6 g	
Material	PBT (Black)	
Terminal	Pin type (Au Plating)	See attached drawing
RoHS	yes	

Frequency Response Curve

Appearance Drawing

 Tolerance: ± 0.5

Measurement Method

Mechanical Characteristics

Item	Test Condition	Evaluation Standard
Solderability	Lead terminals are immersed in rosin for 5 seconds and then immersed in solder bath of $270 \pm 5^{\circ}\text{C}$ for 3 ± 1 seconds.	90% surface of lead terminals should be wet with solder. (Except the edge of the terminal)
Soldering Heat Resistance	Lead terminals are immersed up to 1.5mm from the buzzer's body in a solder bath of $260 \pm 5^{\circ}\text{C}$ for 3 ± 1 seconds.	No in interference in operation.
Terminal Mechanical Strength	Apply force of 9.8 N (1.0 kg) to the terminal for 10 seconds in each axial direction.	No damage or cutting off.
Vibration	The buzzer will be measured after applying a vibration amplitude of 1.5mm with 10 to 55 Hz band of vibration frequency to each of the 3 perpendicular directions for 2 hours.	After the test, the part should meet specifications without any damage to the appearance and performance. The SPL should be within ± 10 dBA when compared to the initial measurement.
Drop Test	The part is to be dropped from a height of 75 cm onto a 40 mm thick wooden board 3 times in 3 axis (X, Y, Z) for a total of 9 drops.	

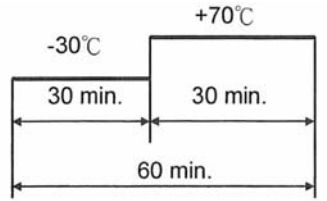
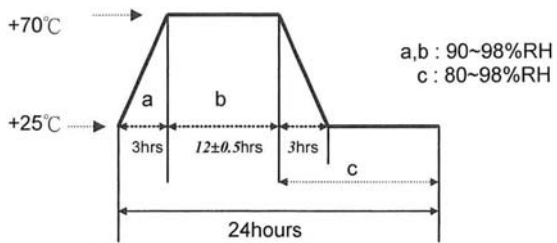
Environment Test

Item	Test Condition	Evaluation Standard
High temp. test	The part will be subjected to $+70^{\circ}\text{C}$ for 96 hours.	After the test, the part shall meet specifications without any damage to the appearance except SPL. After 4 hours at $+25^{\circ}\text{C}$, the SPL should be within ± 10 dBA of the initial SPL.
Low temp. test	The part will be subjected to -30°C for 96 hours	
Thermal shock	The part will be subjected to 10 cycles. One cycle will consist of: <div style="text-align: center;">  </div>	
Temp./Humidity cycle	The part shall be subjected to 10 cycles. One cycle will be 24 hours and consist of: <div style="text-align: center;">  </div>	



Reliability Tests

Item	Test Condition	Evaluation Standard
Operating (Life Test)	1. Continuous life test: The part will be subjected to 72 hours at 45°C with 1.5 V, 2400 Hz applied. 2. Intermittent life test: A duty cycle of 1 minute on, 1 minute off, a minimum of 10,000 times at room temp. (+25±10°C) with 1.5 V, 2400 Hz applied.	After the test, the part shall meet specifications without any damage to the appearance. After 4 hours at +25°C, the SPL should be within ±10 dBA of the initial SPL.

Test Conditions

Standard Test Condition	a) Temperature: +5 ~ +35°C	b) Humidity: 45 - 85%	c) Pressure: 860 - 1060 mbar
Judgement Test Condition	a) Temperature: +25±2°C	b) Humidity: 60 - 70%	c) Pressure: 860 - 1060 mbar



Packaging

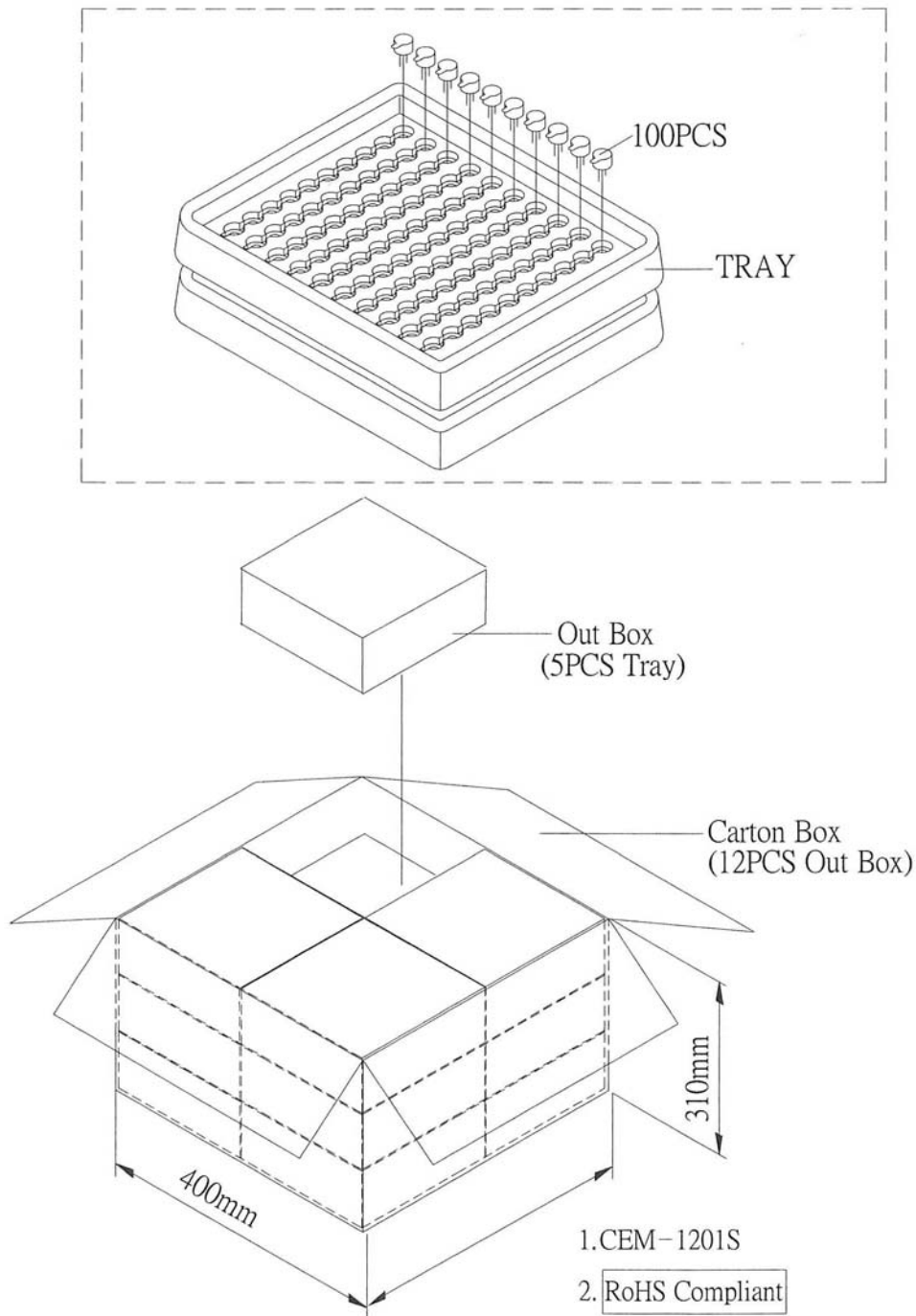

Tray	184mmx184mmx23mm	1x100PCS=100PCS
Out Box	200mmx190mmx100mm	5LAYERx100PCS=500PCS
Carton Box	440mmx400mmx310mm	500PCSx12=6000PCS